

WVC-700 micro inverter

WiFi/433MHz Version **User manual**



WVC Series micro inverter

WVC700-433/WiFi Micro inverter



Parameter

model	WVC700-R3-433/WiFi	
Maximum input power	800Watt	
Output voltage mode	120/230V Auto switch	
PV Open circuit voltage	30-60VOC	
Operating voltage range	22-60V	
Starting voltage range	22-60V	
short-circuit current	32A	
Maximum working current	28A	
Output parameters	@120V	@230V
Output peak power	800Watt	800Watt
Rated output power	700Watt	700Watt
Output current	5.9A	3.05A
AC voltage range	80-160VAC	180-280VAC
AC frequency range	48-51Hz/58-61Hz	48-51Hz/58-61Hz
Power factor	>95%	>95%
Number of branch connections	6PCS (Single)	12PCS (Single)
Output efficiency	@120V	@230V
Static MPPT efficiency	99.5%	99.5%
Max output efficiency	95%	95%
Loss of power at night	<0.5W	<0.5W
Total current harmonics	<5%	<5%
Appearance and technical features		
Temperature range	-40°C to +65°C	
Size (L×W×H)	283mm×200mm×41.6mm	
Net amount	1.56kg	
Waterproof grade	Ip65 NEMA3R	
Heat dissipation mode	Self-cooling	
Communication mode	433MHz/WiFi	
Power transmission mode	Reverse transmission, Load priority	
monitoring system	Mobile phone APP、 Browser	
electromagnetic compatibility	EN50081.part1 EN50082.Part1.CSA STD.C22.2 No.107.1	
Power grid	EN61000-3-2 EN62109.UL STD.1741	
Power grid detection	DIN VDE 0126 IEEE STD.1547.1547.1 and 1547.A	
certificate	CEC , CE , INMETOR , ETL , Patented technology	
Packing weight		
Specifications	Each (Packing)	Box (5PCS)
weight	2.8KG	14KG
Size	342×240×115mm	440×380×260mm

Features

- Maximum power point tracking
- Adaptive voltage/frequency
- App monitoring system
- Reverse power transmission
- Internal high precision meter
- Forward full-bridge topology
- I / O, fully isolated
- Voltage mode microgrid
- No installation, no maintenance
- Multiple parallel stacks
- 5G Iot Platform management

System

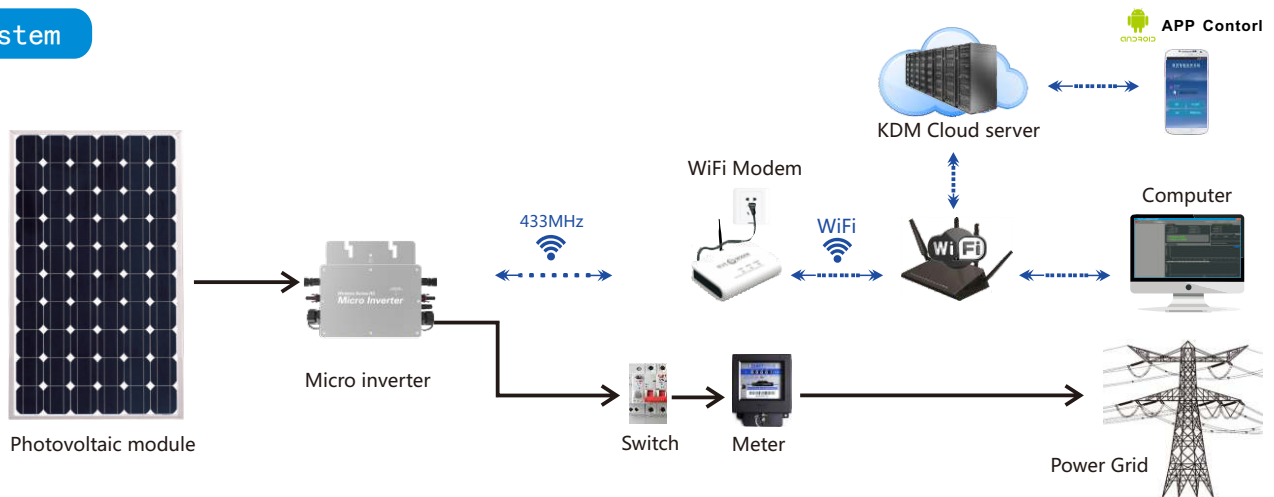

WVC Series micro inverter

Appearance description of micro inverter

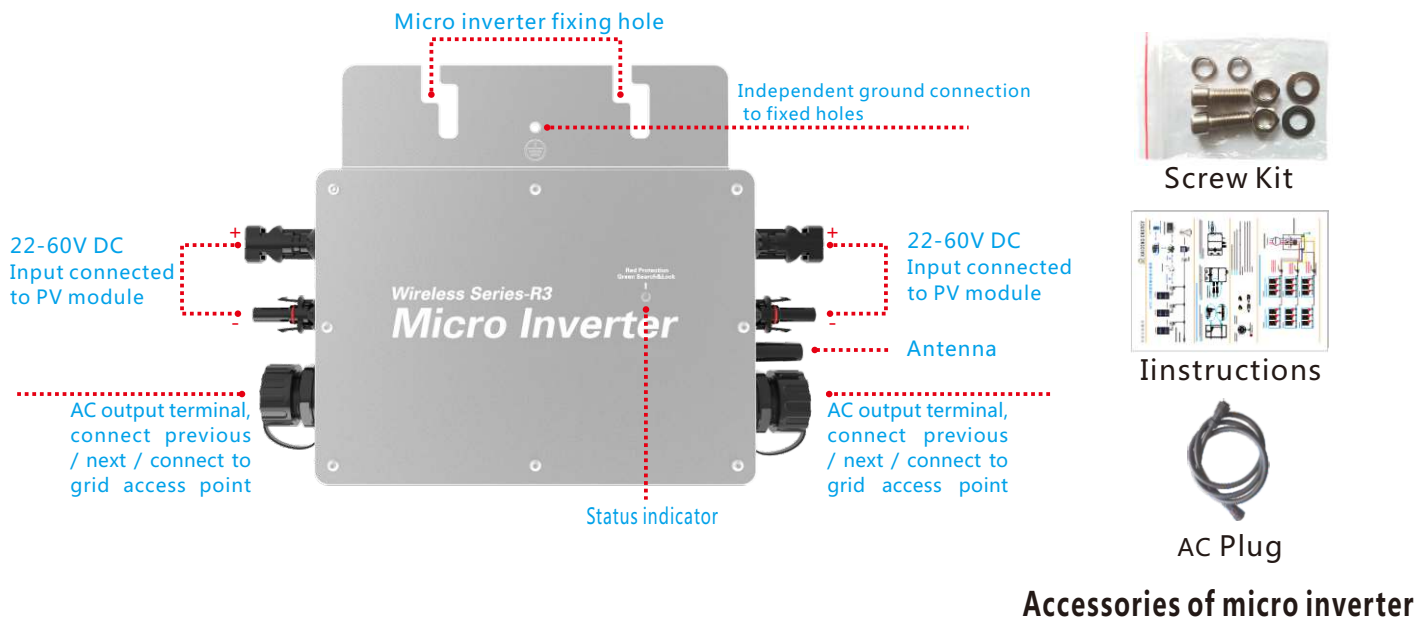

Description of the connector and cable core of the micro inverter

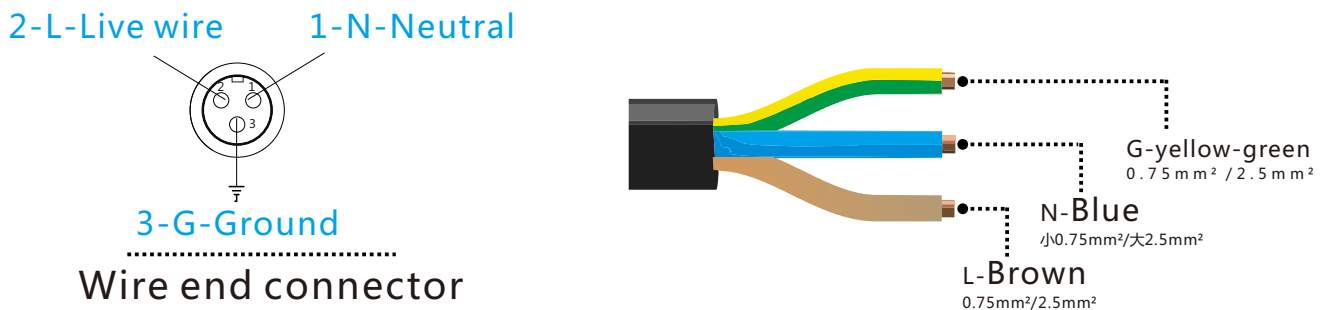

LED indicator function of micro inverter

- 1.Red light is on---The micro-inverter is powered on, the red light is on, and the equipment is ready to work;
- 2.Red light flashes----The micro-inverter is fully prepared and enters the delayed startup state;
- 3.Flashing green-----MPPTMaximum power point search status;
- 4.Green light is on----MPPTMaximum power point locked state;
- 5.The green light turns red----a.Island protection; b. Frequency protection; c. AC over/under-voltage protection; d. DC voltage over and under voltage protection; e. fault; f. software shutdown;

Normal working indicator flashing process:

Connect the micro-inverter to the AC and DC terminals, and then turn on the power → the red light will be on for 3 seconds → the red light will flash for 30 seconds → the green light will flash quickly (MPPT maximum power point search) → The green light is on, (MPPT lock).

WVC Series micro inverter

433MHz Long distance communication

The communication method of 433MHz is a short connection method, that is, the signal is disconnected after sending / receiving. The device for data collection with the inverter is WiFi-MODEM. The communication channel is civilian channel. Long-distance wireless transmission (open area up to 1800 meters, good wall penetration capability, air baud rate 500bps) Operating frequency range (433.4-473.0MHz, up to 100 communication channels) Maximum 100mW (20dBm) transmit power 8 levels of power can be set) Four working modes, suitable for different applications, please refer to the WiFi-MODEM instruction manual for specific usage details.

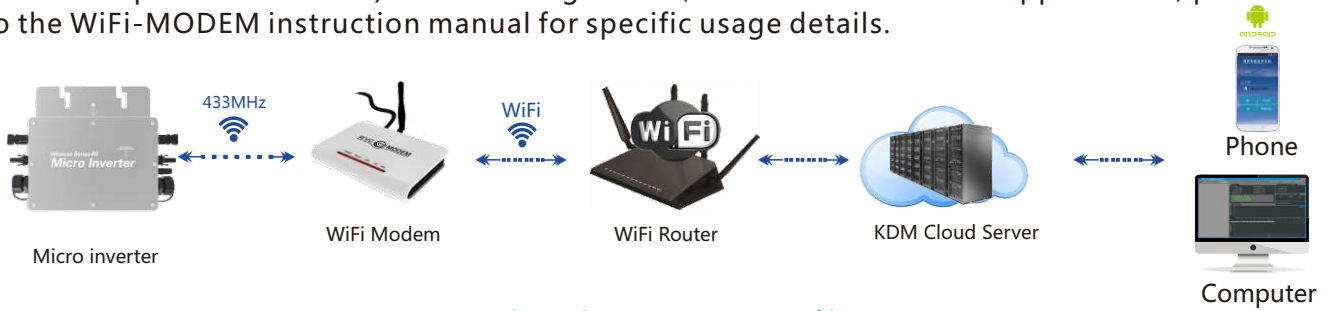

Power monitoring system diagram

Data collection: power, voltage, current, temperature
Data analysis: power and electricity year, month, day, analysis
Function control: remote control of power on / off and power adjustment
Data storage: Cloud platform data storage data will never be lost
Fault alarm: monitor the operation of the equipment throughout the process, at a glance

WiFiData collector usage settings

1、Preparation for use :

If you want to use the monitoring system of WVC series micro-inverters, you must install and set up WVC series WiFi data collector. WiFi data collector is the data exchange bridge of WVC series micro-inverters. It is in the micro-inverter and mobile APP, The function of data collection and data exchange between computers, using 433MHz signal to send the voltage, current, temperature, power and other data of the micro-inverter to the KDM server via WiFi signal, mobile APP / computer can smoothly monitor the power generation data of the power station , Please connect the antenna and power cable of the data collector as shown on the right.

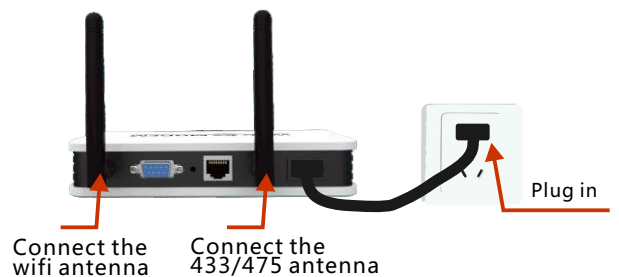

WiFi Modem hardware connection diagram

WVC Series micro inverter

2、APP Phone Settings :

A) Please visit our company's official website to download the kaideng-app.apk app and install it on your Android phone, then click the Kaideng app to enter the login interface, then click the collector to initialize.As shown in Figure 1:

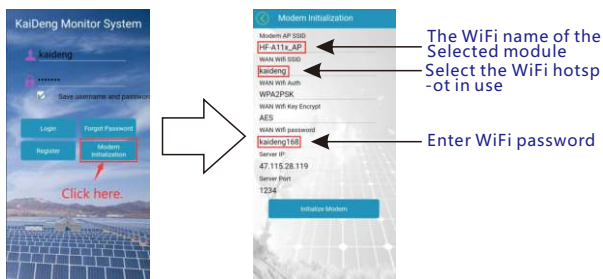

Figure 1

Figure 2

B) As shown in Figure 2, click the red circle to select HF-A11x_AP in the AP SSID of the collector, click the company WiFi SSID to select the WiFi network name in your home, and enter the password in the WiFi password.

C) After all are entered, first select the drop-down menu of the mobile phone and long press the network to select the HF-A11x_AP connection, as shown in Figure 3, and close the data connection of the mobile phone, as shown in Figure 4:

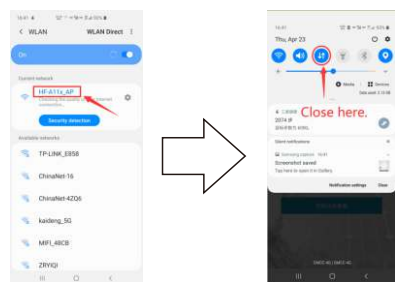

Figure3

Figure4

D) After all are entered, first select the drop-down menu of the mobilephone and long press the network to select the HF-A11x_AP connection, as shown in Figure 3, and close the data connection of the mobile phone, as shown in Figure 4:

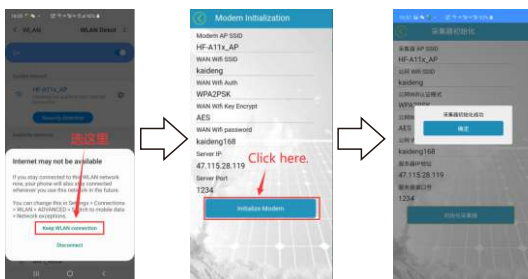

Figure5

Figure6

Figure7

E) Most smartphones automatically select a network. When the connected network pops up and there is no Internet access signal, be sure to choose to keep connected to ensure that the initialization is carried out smoothly, as shown in Figure 5, and the initialization is completed at the last point, as shown in Figure 6 As shown.

Note: Because HF-A11x_AP is not connected to the Internet, the Android phone will automatically disconnect the network, which will make our initialization unsuccessful. Please find the automatic switching function in the Android phone's system settings and turn it off.

3、Computer Settings :

A) Click on the computer to connect to the WiFi network of HF-A11x_AP as shown in Figure 8, open the browser in the computer, enter the IP address: 10.10.100.254, enter in the name: admin, enter in the password field: admin.

As Shown in Figure 9:



Figure8

Figure9

1. Select STA mode on Mode Selection, as shown in Figure 10:
2. Click Search on the STA Interface Setting to search the network as shown in Figure 11:



Figure10

Figure11

3. Select your own network in the searched network list as shown in Figure 12:
4. Click Search on the STA Interface Setting to search the network, and enter the password in the Pass Phrase and click Apply, as shown in Figure 13:

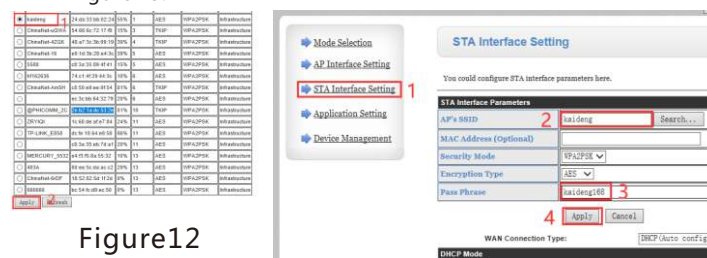

Figure12

Figure13

5. In Application Setting, select Mode as Client> enter Port 1234> enter Server Address 47.115.28.119> click Apply to confirm as shown in Figure 14:
6. Restart the device in Device Management to complete the settings as shown in Figure 15:

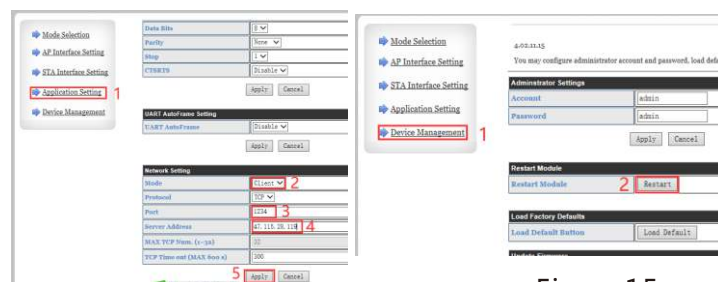

Figure14

Figure15

WVC Series micro inverter

4、 Use of APP :

Please visit our company's official website to download the kaideng-app.apk app and install it on your Android phone, then click the Kaideng app to enter the login interface, click to register a new account, then click to log in to the power station interface and click Add Power Station as shown on the right.

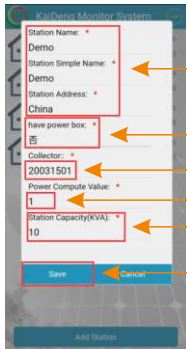

Address information
 "No" must be entered here
 Found behind the collector
 "1" must be entered here
 Fill in the actual installed capacity
 Click here to complete

Please enter each item related to the power station, select "No" in the option of whether there is an electric box, fill in the number in the bar code behind the collector, enter "1" in the calculation ratio, the other according to the actual Just enter.



Enter the code of the inverter
 Click add
 The added inverter

Add the inverter to the inverter addition page, enter the inverter code in the Inverter Code field, and then click Single Add to complete the addition of the inverter, as shown on the left.

The pictures on the right are "Inverter Data Detail Page" and "Inverter List Page". To view the data details of a single inverter, click the icon in the inverter list to open the inverter data Details.

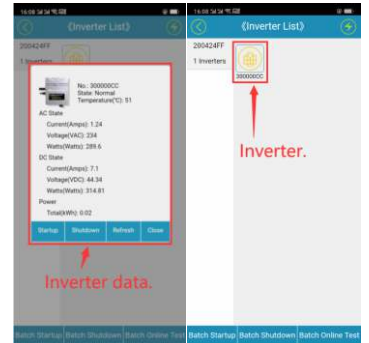

4、 Immediately monitor your power plant and keep track of your power plant data :

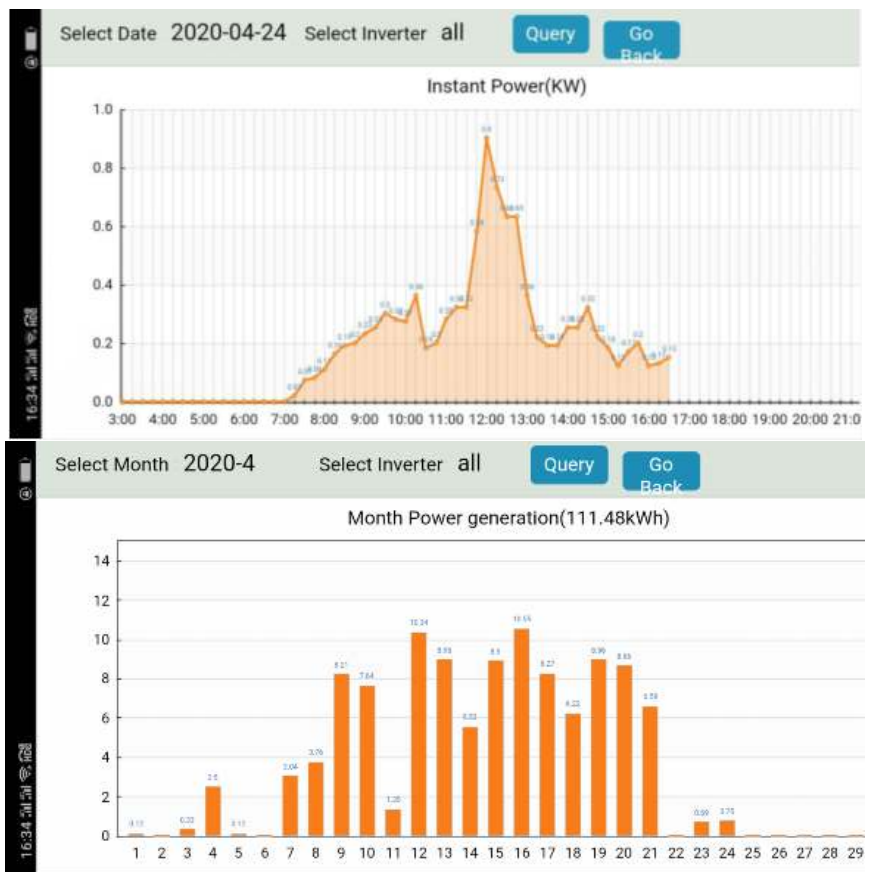
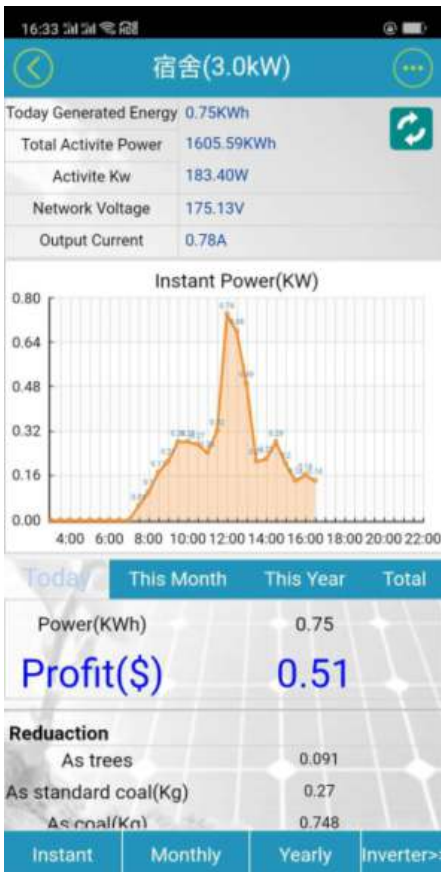

WVC Series micro inverter

WVC series micro-inverter installation guide

To properly install and use WVC series micro inverters, please read and follow this guide and all warnings and instructions in Kay Energy WVC micro inverters. The "Installation and Operation Manual" can be downloaded from the official website of Kaden Energy: www.kaidengdg.com. Safety warnings are listed on the back of this guide. All models of WVC Series Micro inverter listed in this guide have a ground wire in the AC cable, no additional ground electrode is required (EGC), there are three wires inside the AC cable with equipment, which are Blown zero line N (Blue) ground wire / safety line G (Yellow & green). Each micro-inverter is equipped with an AC cable with a length of 3 * 4 * 2 meters. The current of each AC cable branch cannot be greater than 40A. For the number of connected branches of each branch, refer to the following installation guide.

Important information: WVC series micro-inverters use IP65 waterproof rating. When installing, please try to install it in a place where there is no rain, nor in a place where the sun is exposed to ensure ventilation and heat dissipation.

Preparation before installation:

1. Please visit our company's official website to download the kaideng-app.apk app to install on your Android phone, then open the app and register an account on it, and create a power station on the account to reverse the WVC series. The inverter is monitored or controlled. For detailed operation, please refer to the instructions in the inverter monitoring section.



2. The device for data collection with the inverter communication is WiFi-MODEM, and the communication method between WiFi-MODEM and inverter is long-distance wireless transmission (open field 1800 meters, air baud rate 00bps). Operating frequency range (433.4-473.0MHz Up to 100 communication channels) Maximum 100mW (20dBm) transmit power (8 levels of power can be set) Four working modes, suitable for different applications, please refer to the WiFi-MODEM manual for details.

3. Please refer to the following list and compare the electrical parameters of the solar modules in the table to select the inverter model.

Inverter model	Connector	Photovoltaic module
WVC-295	1*MC4	The number of matched photovoltaic modules is 60 strings / 72 strings / 90 strings. The open circuit voltage Voc is between 30-60V
WVC-300	1*MC4	
WVC-350	1*MC4	
WVC-600	2*MC4	
WVC-700	2*MC4	
WVC-1000	2*MC4	
WVC-1200	4*MC4	
WVC-1400	4*MC4	
WVC-1600	4*MC4	
WVC-2000	4*MC4	

4. In addition to Kaideng Energy's WVC series micro-inverters, you must also purchase photovoltaic brackets / AC boxes / electrical cables and other related materials. The current of each channel of the WVC series micro-inverters at the branch of the installed circuit cannot exceed 40 Amp, if the rated current is exceeded, it may lead to an unsafe factor.
5. Check if you still have the following related equipment: AC junction box, tools: screwdriver, wire cutter, voltmeter, torque wrench, socket and wrench for installing hardware, etc.

6. After the installation of the power station is completed, please install a ground wire on the photovoltaic support, install and use a lightning protection and / or surge suppression equipment protection system in the AC junction box. It is very important to have a switch device that automatically protects against lightning strikes and surges.
7. When installing the inverter handshake cable, please plan that your AC branch circuit cannot exceed the current limit, so that the maximum number of micro-inverters in each branch can be reasonably allocated.

Inverter model	Number of branches
WVC-295	30PCS
WVC-300	30PCS
WVC-350	25PCS
WVC-600	15PCS
WVC-700	12PCS
WVC-1000	10PCS
WVC-1200	8PCS
WVC-1400	6PCS
WVC-1600	5PCS
WVC-2000	5PCS

*Each region may be different. Please refer to local requirements to define the number of micro-inverters per branch in your area.

8. Implement all national electrical codes (NEC), ANSI / NFPA 70 in accordance with all local electrical codes and all relevant regulations.
9. Please note that only qualified personnel can install and / or replace Kaideng micro-inverters.
10. Please do not try to repair Kaideng micro-inverter. It does not contain user-serviceable parts. If it fails, please contact Kaideng customer service to obtain the ID number and start the replacement process. Tampering or opening the Kaideng micro inverter will invalidate the warranty.
11. Before installing or using Kaideng Micro Inverter, please read all instructions and technical instructions and the warning mark system and photovoltaic array on Kay Microinverter.
12. Please make sure that the installation operation is performed before the AC power is disconnected, and do not install the Kaideng micro-inverter with power on.
13. Please install Kayden micro inverter series products as shown in the following figure.

WVC Series micro inverter

WVC-700 micro inverter installation drawing

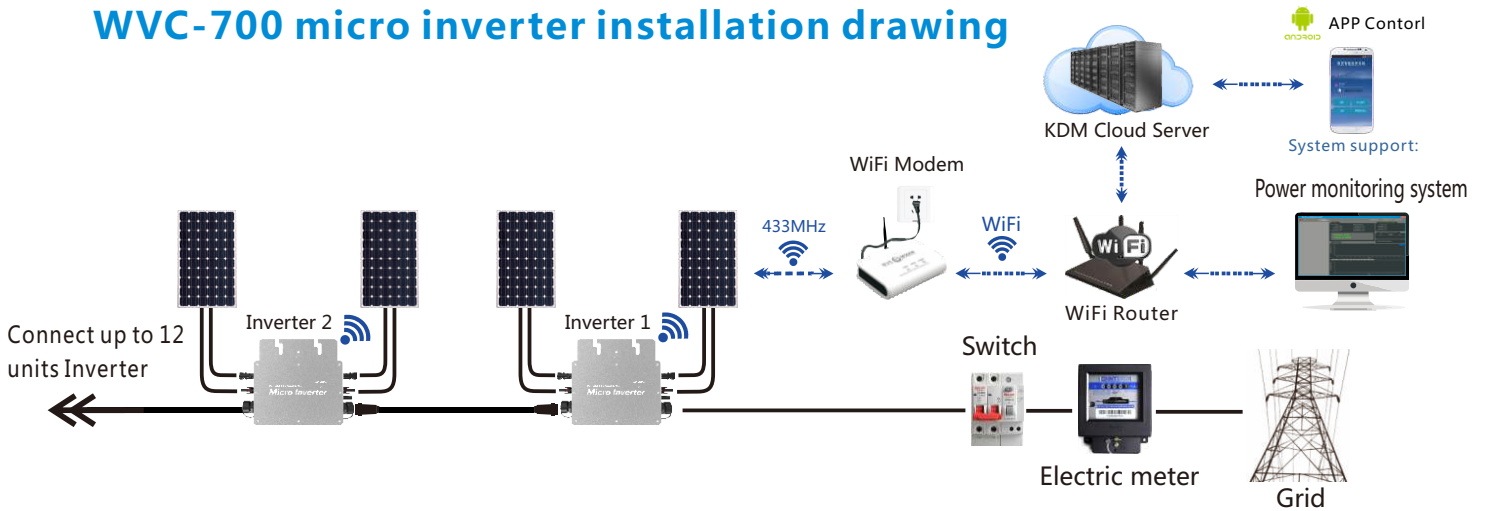

Inverter installation steps

Step1 Install the inverter on the bracket of the photovoltaic panel with the screws provided with the machine, as shown in the following figure:

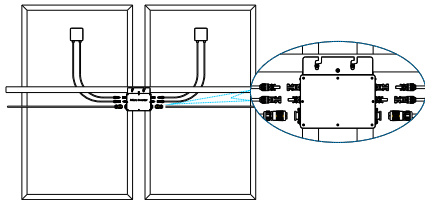

Step2 Connect the positive and negative poles of the DC connection MC4 plug on the photovoltaic board to the DC input terminal of the inverter, as shown below:

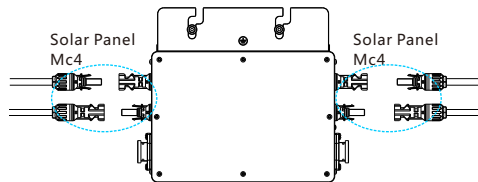

Step3 Open the waterproof cover of the AC output connector of the inverter and connect the AC cable to the AC waterproof plug. The connection method is as shown in the plug connection diagram:

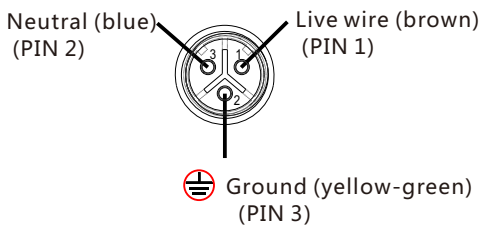
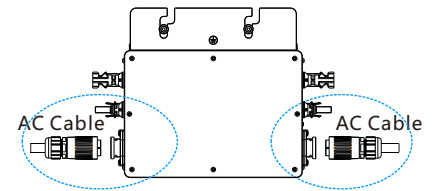

Step 4 Connect the AC output cable to the AC main cable;

Step 5 Repeat steps 1 to 3, install and connect all inverters;

Step 6 Connect the AC main cable to the utility grid to start your green energy journey.

Note: Before installing WVC series micro inverter products, please read this manual and pay attention to the installation details.

This manual contains important instructions that should be followed when installing and maintaining. Reduce the risk of electric shock and ensure safe installation and operation of Kaideng MicroInverters. Always follow the following safety symbols present in this document to indicate hazardous conditions and important safety instructions.

Wiring Diagram WVC-700 Triple Phase

